

FAIRCHILD

A Schlumberger Company

IRF340-343/IRF740-743 T-39-13
MTM8N35/8N40
N-Channel Power MOSFETs,
10 A, 350 V/400 V

Power And Discrete Division

Description

These devices are n-channel, enhancement mode, power MOSFETs designed especially for high voltage, high speed applications, such as off-line switching power supplies, UPS, AC and DC motor controls, relay and solenoid drivers.

- V_{GS} Rated at ± 20 V
- Silicon Gate for Fast Switching Speeds
- I_{DSS} , $V_{DS(on)}$, SOA and $V_{GS(th)}$ Specified at Elevated Temperature
- Rugged

TO-204AA

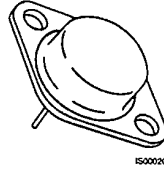

IRF340
 IRF341
 IRF342
 IRF343
 MTM8N35
 MTM8N40

TO-220AB

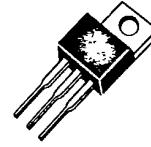

IRF740
 IRF741
 IRF742
 IRF743

Maximum Ratings

Symbol	Characteristic	Rating IRF340/342 IRF740/742 MTM8N40	Rating IRF341/343 IRF741/743 MTM8N35	Unit
V_{DSS}	Drain to Source Voltage	400	350	V
V_{DGR}	Drain to Gate Voltage $R_{GS} = 1.0 M\Omega$	400	350	V
V_{GS}	Gate to Source Voltage	± 20	± 20	V
T_J, T_{stg}	Operating Junction Temperature Storage Temperature	-55 to +150	-55 to +150	$^{\circ}C$
T_L	Maximum Lead Temperature for Soldering Purposes, 1/8" From Case for 5 s	275	275	$^{\circ}C$

Maximum On-State Characteristics

		IRF340/341 IRF740/741	IRF342/343 IRF742/743	MTM8N35 MTM8N40	
$R_{DS(on)}$	Static Drain-to-Source On Resistance	0.55	0.80	0.55	Ω
I_D	Drain Current Continuous Pulsed	10 40	8 32	8 48	A

Maximum Thermal Characteristics

$R_{\theta JC}$	Thermal Resistance, Junction to Case	1.0	1.0	0.83	$^{\circ}C/W$
P_D	Total Power Dissipation at $T_C = 25^{\circ}C$	125	125	150	W

Notes

For information concerning connection diagram and package outline, refer to Section 7.

IRF340-343/IRF740-743

T-39-13

Electrical Characteristics ($T_C = 25^\circ\text{C}$ unless otherwise noted)

Symbol	Characteristic	Min	Max	Unit	Test Conditions
Off Characteristics					
$V_{(BR)DSS}$	Drain-Source Breakdown Voltage ¹			V	$V_{GS} = 0\text{ V}$, $I_D = 250\ \mu\text{A}$
	IRF340/342/740/742	400			
	IRF341/343/741/743	350			
I_{DSS}	Zero Gate Voltage Drain Current		250	μA	$V_{DS} = \text{Rated } V_{DSS}$, $V_{GS} = 0\text{ V}$
			1000	μA	$V_{DS} = 0.8 \times \text{Rated } V_{DSS}$, $V_{GS} = 0\text{ V}$, $T_C = 125^\circ\text{C}$
I_{GSS}	Gate-Body Leakage Current IRF340-343 IRF740-743		± 100 ± 500	nA	$V_{GS} = \pm 20\text{ V}$, $V_{DS} = 0\text{ V}$

On Characteristics

$V_{GS(th)}$	Gate Threshold Voltage	2.0	4.0	V	$I_D = 250\ \mu\text{A}$, $V_{DS} = V_{GS}$
$R_{DS(on)}$	Static Drain-Source On-Resistance ² IRF340/341/740/741 IRF342/343/742/743			Ω	$V_{GS} = 10\text{ V}$, $I_D = 5.0\text{ A}$
			0.55		
			0.80		
g_{fs}	Forward Transconductance	4.0		S (Ω)	$V_{DS} = 10\text{ V}$, $I_D = 5.0\text{ A}$

Dynamic Characteristics

C_{iss}	Input Capacitance		1600	pF	$V_{DS} = 25\text{ V}$, $V_{GS} = 0\text{ V}$ $f = 1.0\text{ MHz}$
C_{oss}	Output Capacitance		450	pF	
C_{rss}	Reverse Transfer Capacitance		150	pF	

Switching Characteristics ($T_C = 25^\circ\text{C}$, Figures 9, 10)

$t_{d(on)}$	Turn-On Delay Time		35	ns	$V_{DD} = 175\text{ V}$, $I_D = 5.0\text{ A}$ $V_{GS} = 10\text{ V}$, $R_{GEN} = 4.7\ \Omega$ $R_{GS} = 4.7\ \Omega$
t_r	Rise Time		15	ns	
$t_{d(off)}$	Turn-Off Delay Time		90	ns	
t_f	Fall Time		35	ns	
Q_g	Total Gate Charge		60	nC	$V_{GS} = 10\text{ V}$, $I_D = 12\text{ A}$ $V_{DD} = 400\text{ V}$

Symbol	Characteristic	Typ	Max	Unit	Test Conditions
Source-Drain Diode Characteristics					
V_{SD}	Diode Forward Voltage IRF340/341/740/741 IRF342/343/742/743		2.0	V	$I_S = 10\text{ A}$; $V_{GS} = 0\text{ V}$ $I_S = 8\text{ A}$; $V_{GS} = 0\text{ V}$
			1.9	V	
t_{rr}	Reverse Recovery Time	600		ns	$I_S = 10\text{ A}$; $di_S/dt = 100\text{ A}/\mu\text{S}$

MTM8N35/8N40

T-39-13

Electrical Characteristics ($T_C = 25^\circ\text{C}$ unless otherwise noted)

Symbol	Characteristic	Min	Max	Unit	Test Conditions
Off Characteristics					
$V_{(BR)DSS}$	Drain-Source Breakdown Voltage ¹			V	$V_{GS} = 0\text{ V}$, $I_D = 5.0\text{ mA}$
	MTM8N40	400			
	MTM8N35	350			
I_{DSS}	Zero Gate Voltage Drain Current		0.25	mA	$V_{DS} = 0.85 \times \text{Rated } V_{DSS}$, $V_{GS} = 0\text{ V}$
			2.5	mA	$V_{DS} = 0.85 \times \text{Rated } V_{DSS}$, $V_{GS} = 0\text{ V}$, $T_C = 100^\circ\text{C}$
I_{GSS}	Gate-Body Leakage Current		± 500	nA	$V_{GS} = \pm 20\text{ V}$, $V_{DS} = 0\text{ V}$

On Characteristics

$V_{GS(th)}$	Gate Threshold Voltage	2.0	4.5	V	$I_D = 1.0\text{ mA}$, $V_{DS} = V_{GS}$
		1.5	4.0	V	$I_D = 1.0\text{ mA}$, $V_{DS} = V_{GS}$ $T_C = 100^\circ\text{C}$
$V_{DS(on)}$	Drain-Source On-Voltage ²		2.2	V	$V_{GS} = 10\text{ V}$; $I_D = 4.0\text{ A}$
			5.3	V	$V_{GS} = 10\text{ V}$; $I_D = 8.0\text{ A}$
			4.4	V	$V_{GS} = 10\text{ V}$, $I_D = 4.0\text{ A}$ $T_C = 100^\circ\text{C}$
$R_{DS(on)}$	Static Drain-Source On-Resistance ²		0.55	Ω	$V_{GS} = 10\text{ V}$, $I_D = 4.0\text{ A}$
g_{fs}	Forward Transconductance	3.0		S (Ω)	$V_{DS} = 10\text{ V}$, $I_D = 4.0\text{ A}$

Dynamic Characteristics

C_{iss}	Input Capacitance		1800	pF	$V_{DS} = 25\text{ V}$, $V_{GS} = 0\text{ V}$ $f = 1.0\text{ MHz}$
C_{oss}	Output Capacitance		350	pF	
C_{rss}	Reverse Transfer Capacitance		150	pF	

Switching Characteristics ($T_C = 25^\circ\text{C}$, Figures 9, 10)³

$t_{d(on)}$	Turn-On Delay Time		60	ns	$V_{DD} = 25\text{ V}$, $I_D = 4.0\text{ A}$ $V_{GS} = 10\text{ V}$, $R_{GEN} = 50\ \Omega$ $R_{GS} = 50\ \Omega$
t_r	Rise Time		150	ns	
$t_{d(off)}$	Turn-Off Delay Time		200	ns	
t_f	Fall Time		120	ns	
Q_g	Total Gate Charge		60	nC	$V_{GS} = 10\text{ V}$, $I_D = 12\text{ A}$ $V_{DD} = 400\text{ V}$

Notes

- $T_J = +25^\circ\text{C}$ to $+150^\circ\text{C}$
- Pulse test: Pulse width $\leq 80\ \mu\text{s}$, Duty cycle $\leq 1\%$
- Switching time measurements performed on LEM TR-58 test equipment.

**IRF340-343/IRF740-743
MTM8N35/8N40**

T-39-13

Typical Performance Curves

Figure 1 Output Characteristics

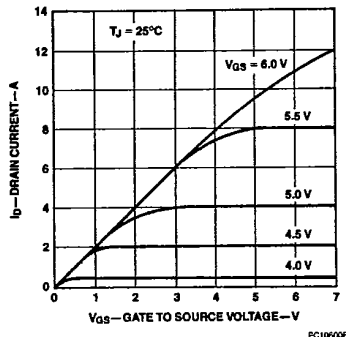

Figure 2 Static Drain to Source Resistance vs Drain Current

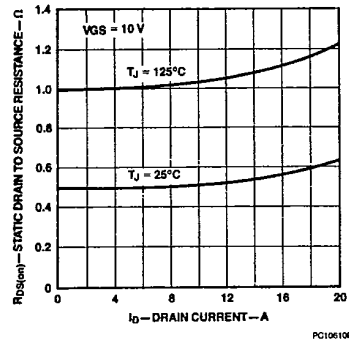

Figure 3 Transfer Characteristics

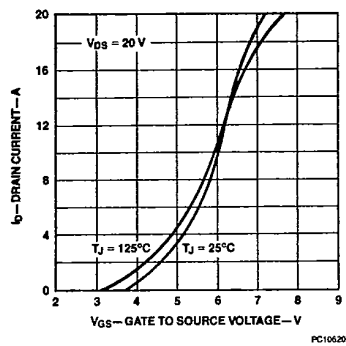

Figure 4 Temperature Variation of Gate to Source Threshold Voltage

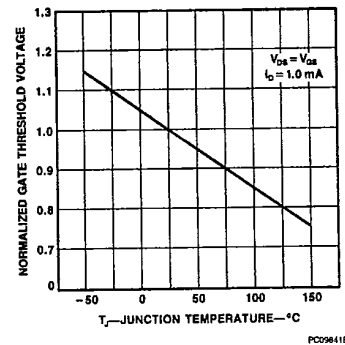

Figure 5 Capacitance vs Drain to Source Voltage

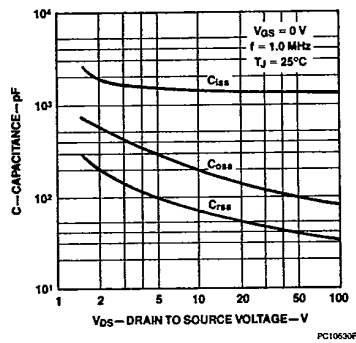
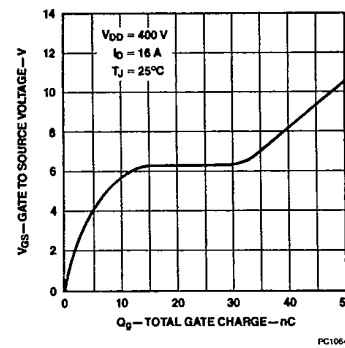

Figure 6 Gate to Source Voltage vs Total Gate Charge



2

**IRF340-343/IRF740-743
MTM8N35/8N40**

T-39-13

Typical Performance Curves (Cont.)

Figure 7 Forward Biased Safe Operating Area

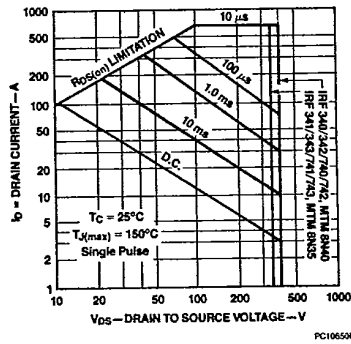
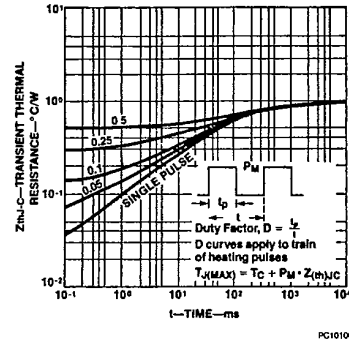

Figure 8 Transient Thermal Resistance vs Time



Typical Electrical Characteristics

Figure 9 Switching Test Circuit

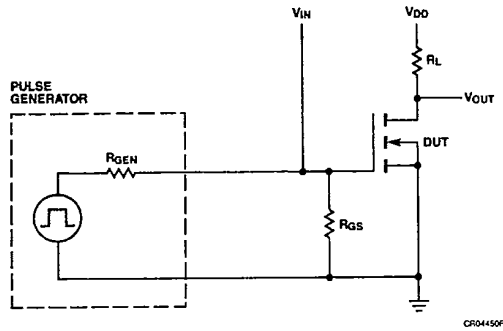

Figure 10 Switching Waveforms

