

## LM1870 Stereo Demodulator with Blend

### General Description

The LM1870 is a phase locked loop FM stereo demodulator with a DC control pin for reducing noise by decreasing separation during weak signal conditions.

### Applications

- Automobile radios
- Hi Fi receivers and tuners
- High performance portable radios

### Features

- Blend control
- Large input overload
- Low beat note distortion
- Low THD diode switching outputs
- VCO stop function
- Wide supply range, 7V to 15V
- Mono override pin

### Typical Application and Test Circuit

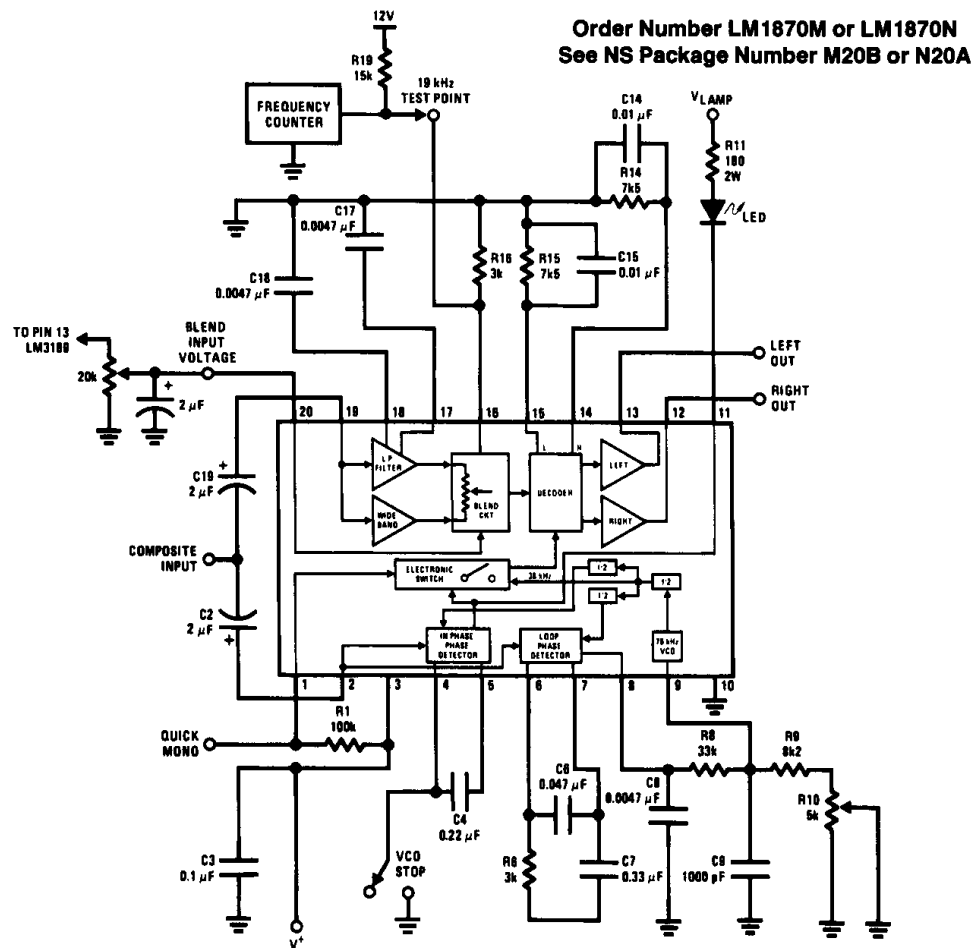

**FIGURE 1**

TL/H/7910-1

### Pin Functions

- |                                |                 |                                  |   |
|--------------------------------|-----------------|----------------------------------|---|
| 1. Quick Mono                  | 6. Loop Filter  | 12. Right Output                 | 16. Blend Resistor and<br>19 kHz Test Point |
| 2. PLL Input                   | 7. Loop Filter  | 13. Left Output                  | 17. Blend Filter                            |
| 3. V+                          | 8. VCO Tuning   | 14. Right Gain and<br>Deemphasis | 18. Blend Filter                            |
| 4. Lamp Filter and VCO<br>Stop | 9. VCO Tuning   | 15. Left Gain and<br>Deemphasis  | 19. Audio Input                             |
| 5. Lamp Filter                 | 10. Ground      |                                  | 20. Blend Control Voltage                   |
|                                | 11. Lamp Driver |                                  |   |

## Absolute Maximum Ratings

If Military/Aerospace specified devices are required, please contact the National Semiconductor Sales Office/Distributors for availability and specifications.

Supply Voltage, Pin 3	15V
Lamp Driver Voltage, Pin 11	18V
Output Voltage, Pin 12, 13, Supply Off	7V
Quick Mono Input (Pin 1)	V <sup>+</sup> (Pin 3)
Blend Input (Pin 20)	15V
Operating Temperature Range	0°C to +70°C
Power Dissipation (Note 1)	1.9W

Storage Temperature	-65°C to +125°C
Soldering Information	
Dual-In-Line Package	
Soldering (10 sec)	260°C
Small Outline Package	
Vapor Phase (60 sec)	215°C
Infrared (15 sec)	220°C

See AN-450 "Surface Mounting Methods and Their Effect on Product Reliability" for other methods of soldering surface mount devices.

## Electrical Characteristics $T_A = 25^\circ\text{C}$ , $V^+ = 8\text{V}$ , Figure 1

Parameter	Conditions	Min	Typ	Max	Units
<b>DC</b>					
Operating Supply Voltage		7	8	15	V
Supply Current			26	45	mA
Input DC Voltage	Pin 19		4		V
Input DC Voltage	Pin 2		1.8		V
Supply Rejection		15	30		dB
Lamp Leakage Current	Lamp Off, Pin 11 = 16V		0.1	100	$\mu\text{A}$
Lamp Saturation Voltage	Lamp On, Pin 11 @ 75 mA		1.4	2.0	V
VCO Stop Voltage	Voltage at Pin 4 to Stop VCO	0.2	0.4		V
VCO Stop Current	Pin 4 = 0.2V		-30	-100	$\mu\text{A}$
Blend Input Bias Current	Pin 20 = 0V		-2	-20	$\mu\text{A}$
Quick Mono Switch Voltage			4		V
Quick Mono Bias Current	Pin 1 = 8V		2		$\mu\text{A}$
Output Leakage	Pin 12 or 13 = 6.5V, Pin 3 = 0V		0.1	20	$\mu\text{A}$
<b>Audio</b>					
Mono Gain	1 kHz	-4	-1	+2	dB
Mono THD	1 kHz @ 200 mVrms		0.05	0.25	%
Channel Balance			$\pm 0.4$	$\pm 1.5$	dB
Gain Shift	Mono to Stereo		$\pm 0.1$	$\pm 1.0$	dB
Channel Separation	Pin 20 $\geq 1.1\text{V}$	30	45		dB
Output DC Shift	Mono to Stereo		$\pm 15$	$\pm 100$	mV
Input Resistance	Pin 19	20	40		k $\Omega$
Output Resistance	Pin 12, 13		65	200	$\Omega$
Ultrasonic Rejection	19 kHz + 38 kHz		30		dB
SCA Rejection	(Note 2)		70		dB
Signal to Noise	1 kHz @ 200 mVrms Mono		68		dB
<b>PLL</b>					
Lamp On Voltage	19 kHz on Pin 2		15	20	mV
Lamp Off Voltage	19 kHz on Pin 2	2.5	5		mV
Lamp Hysteresis			10		dB
Capture Range	25 mVrms on Pin 2	$\pm 2$	$\pm 4$	$\pm 6$	%
Hold In Range	25 mVrms on Pin 2		$\pm 12$		%
Input Resistance	Pin 2	8	14		k $\Omega$
<b>Blend</b> <b>Pin 20 from 1.1V to 0.2V</b>					
Stereo Gain Change	1 kHz L = - R Input	-25	-35		dB
Mono Gain Change	1 kHz L = R Input	-1.5	-0.5	0.5	dB
	10 kHz L = R Input	-8	-14	-20	dB
Output DC Shift			$\pm 40$	$\pm 100$	mV

**Note 1:** For operation in ambient temperatures above 25°C, the device must be derated based on a 150°C maximum junction temperature and a thermal resistance of 65°C/W junction to ambient for the DIP and 75°C/W junction-to-ambient for the small outline package.

**Note 2:** Input is 10% SCA (74.5 kHz), 9% pilot and 1 kHz left or right. Rejection is ratio of 1 kHz output to 1.5 kHz output.

## External Components

Part #	Recommended Value	Purpose	Effect		Remarks
			Smaller	Larger	
R1	100k	Pull Up for Quick Mono	OK	Errors Due to Pin 1 Bias Current	Pin 1 Can Be Shorted to Supply if Quick Mono is Not Used
C2	2 $\mu$ F	PLL Input Coupling	Loading of Source Varies with Frequency		For Sources of Less Than 100 $\Omega$ , Can use 0.1 $\mu$ F
C3	0.1 $\mu$ F	Supply Bypass			
C4	0.22 $\mu$ F	Lamp Filter	Shorter Time to Switch Mono to Stereo	Longer Time to Switch Mono to Stereo	High Dielectric Resistance
R6 C6 C7	3k 0.047 $\mu$ F 0.33 $\mu$ F	Loop Filter	High Stereo Distortion	Narrower Capture Range	
R8 C8	33k 0.0047 $\mu$ F	Loop Filter	High Stereo Distortion	Loop Doesn't Lock Narrower Capture Range	
C9 R9 R10	1000 pF 8.2k 5k	Sets VCO Free Running Frequency	High VCO Jitter VCO Not Adjustable with C9	Narrower Capture Range	NPO 5% Metalfilm
R11	180 $\Omega$	Sets Lamp Current	Excess IC Dissipation	Dim Lamp	
R14 R15	7.5k 7.5k	Load Resistors	Low Output Voltage	Output Clips Earlier	
C14 C15	0.01 $\mu$ F 0.01 $\mu$ F	Deemphasis			
R16	3k	Sets Blend Characteristic	See Curves		
C17 C18	0.0047 $\mu$ F 0.0047 $\mu$ F	Filter for Blend	Insufficient Blend	Reduced Blend Bandwidth	
C19	2 $\mu$ F	Audio Input Coupling	Poor Low Frequency Response and Separation	Turn On Delay	
R19	15k	Allows VCO Monitoring	Excess IC Dissipation	Reduces 19 kHz Output Voltage	Only Need During Set Up

## Typical Performance Characteristics Blend off unless otherwise stated

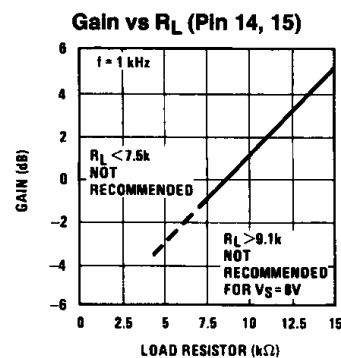
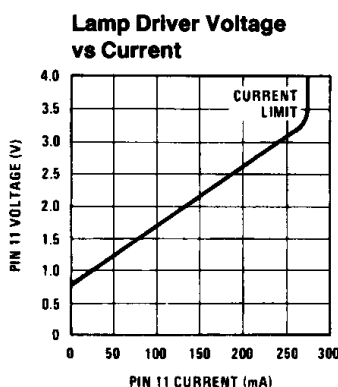
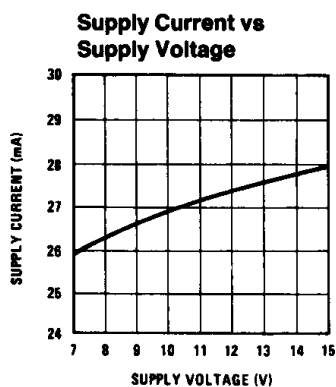

TL/H/7910-2

**Typical Performance Characteristics** Blend off unless otherwise stated (Continued)

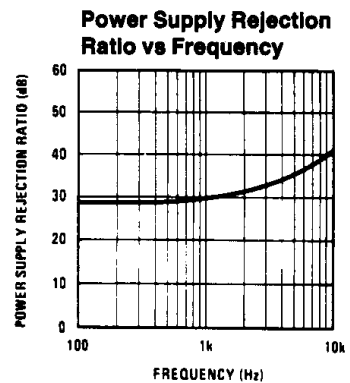
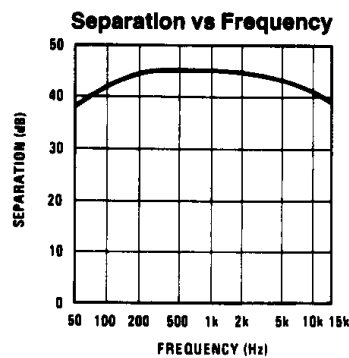
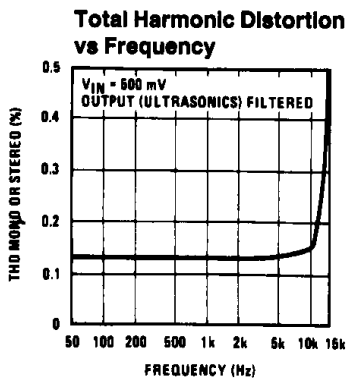
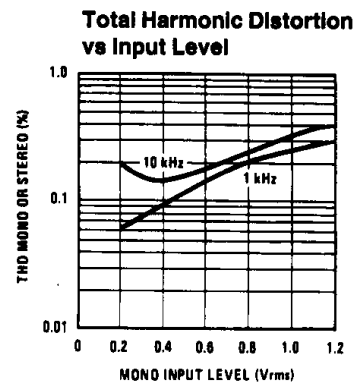
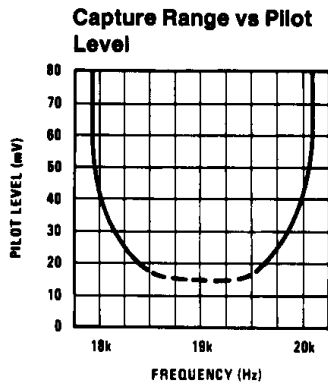
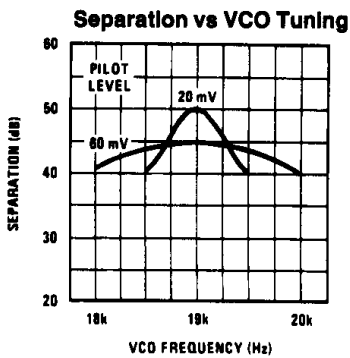
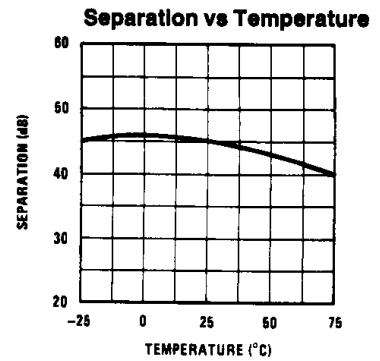
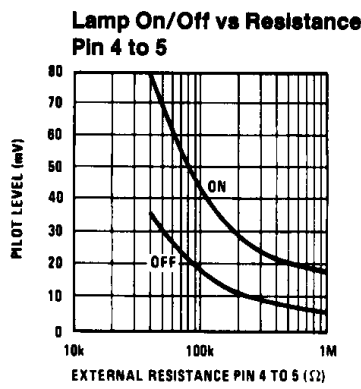
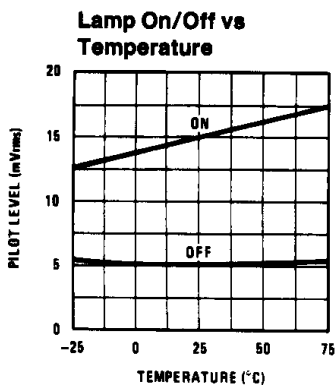
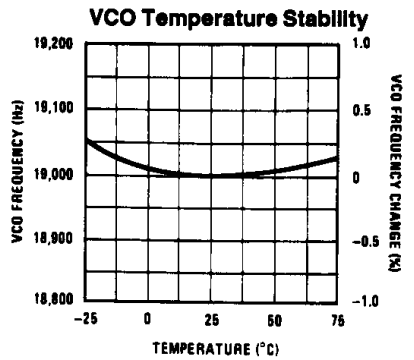
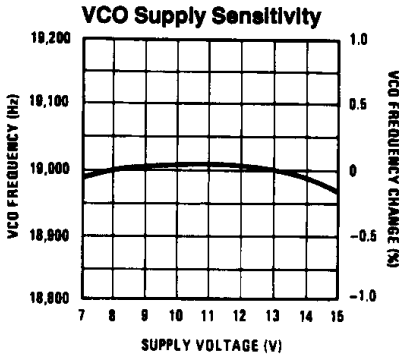
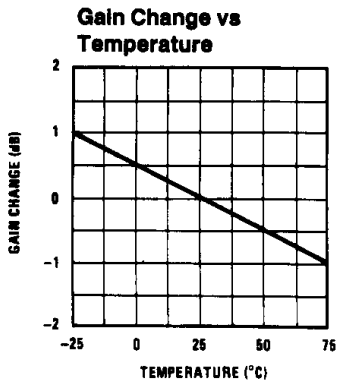

**Typical Performance Characteristics** Blend off unless otherwise stated (Continued)

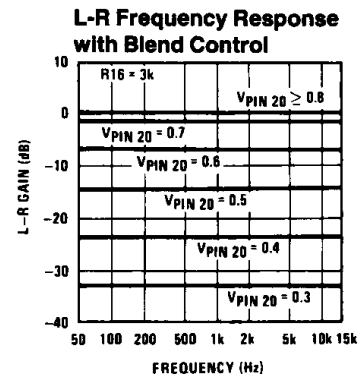
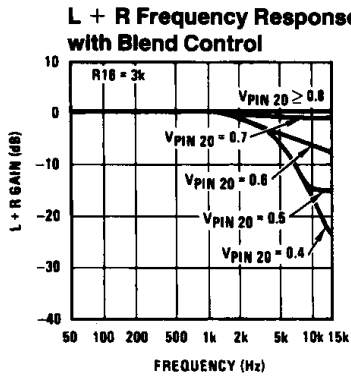
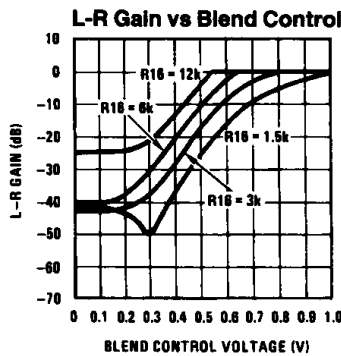

TL/H/7910-4

**Application Hints**

**Blend—What & Why?**

The signal to noise of a weak FM stereo signal is worse than that of an equally weak FM mono signal. For this reason FM mono radios often perform better than FM stereo radios, unless the latter is forced into mono.

The typical quieting curves of an FM stereo radio look like this:

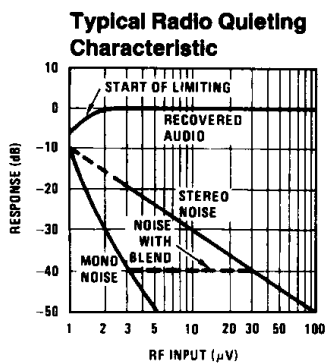

TL/H/7910-5

If an acceptable signal to noise is 40 dB, then 20 dB more signal is required in stereo compared to mono, 30 µV vs 3 µV. The degradation in noise is due to the L-R or difference channel. If the gain of the L-R is reduced, then the noise associated with it will be reduced. However, there will also be a reduction in separation.

To maintain a 40 dB signal to noise in the above example, the gain of the L-R signal should be reduced from 0 dB gain @ 30 µV downward to -20 dB at 3 µV. If this is done properly the dashed line will result. Below is a plot of L-R gain and resulting separation.

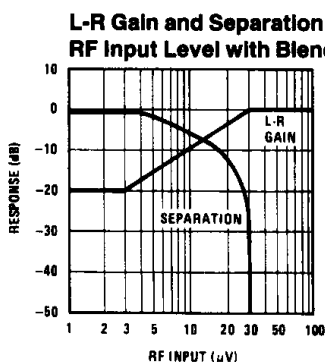

TL/H/7910-6

The LM1870 reduces the gain of the L-R channel before it is demodulated. This is done by a voltage controlled shelving filter. The Bode plot of this filter is shown below:

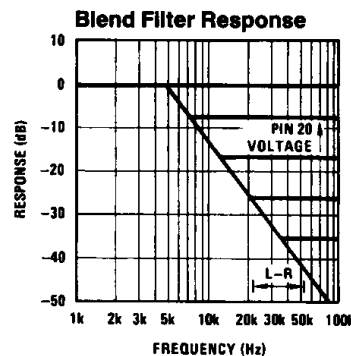

TL/H/7910-7

The full blend response is a two pole roll-off with each pole set by an internal 6.8k resistor and the capacitance from pins 17 and 18 to ground. The standard value for both capacitors is 4.7 nF resulting in two 5 kHz poles. The blend input (pin 20) is derived from the meter drive output of the FM IF chip (LM3089 or LM3189 pin 13). To adjust for variations in RF gain and other IC parameters, it is recommended that an adjustment be made on each radio.

**Mono-Stereo Switching**

The LM1870 automatically switches from mono to stereo when the level of pilot at pin 2 is about 15 mV or more. This value can be increased by putting a resistor between pins 4 and 5, as shown graphically in the Typical Performance curves.

If it is desired to switch to mono without turning off the lamp driver, pin 1 should be taken below 4V. This is a high impedance input that can be electronically switched by a transistor with a pull up resistor to the IC supply.

**Outputs**

The LM1870 has emitter-follower outputs resulting in a low output impedance. The output will sink or source one mA, therefore it will drive AC coupled loads greater than 2 kΩ.

In AM-FM radios the switching can be cumbersome at best. To ease the problem the outputs of the LM1870 (pins 12 and 13) are open circuit when the supply (pin 3) is open or grounded. This reduces the number of switch poles required

## Application Hints (Continued)

since the outputs can remain connected at all times. This technique is commonly called diode switching but the method used in the LM1870 results in substantially lower distortion than obtained with discrete diodes.

### VCO

The stereo performance of the LM1870 is very constant for small (<2%) changes in the free running frequency of the VCO. To insure that the frequency stays within 2%, low temperature coefficient components should be used for the tuning capacitor (1000 pF) and resistor (8.2k). The internal oscillator has a temperature coefficient of about 50 ppm/°C (see curve). With an NPO capacitor and a metalfilm resistor the total variation in the free running frequency will be less than 1% over the full temperature range. Tuning the VCO is done by adjusting the 5 kΩ potentiometer to get 19 kHz  $\pm$  50 Hz with no input on pin 2.

The VCO frequency is monitored at pin 16 when current is supplied to the pin. During normal operation the 19 kHz square wave is not available and the resistor from pin 16 to ground programs the blend characteristics (see curves).

The VCO of the LM1870 can be stopped by taking pin 4 low. In addition to being useful for turning off the stereo indicator and forcing mono FM reception, this also allows other mono sources, such as AM, to be fed into the decoder and come out both channels. The signal will not be inadvertently decoded with the VCO off and it will have the same gain and balance characteristics as the FM. The deemphasis capacitors may need to be removed for proper frequency response. The voltage on pin 20 will also affect the frequency response.

It should be noted that a stopped VCO cannot radiate into the rest of the radio and cause interference. Pin 4 can be taken low with a mechanical switch or an NPN transistor. If a transistor is used it must have low leakage, less than 100 nA at 3V  $V_{CE}$ , and low saturation, less than 200 mV at 100  $\mu$ A collector current.

### PLL

To properly demodulate the L-R signal the decoder must generate a 38 kHz signal that is locked in phase with the 19 kHz pilot signal at the input. This is done with a phase locked loop consisting of a phase detector, a loop filter (pins 6 and 7) and a VCO (pins 8 and 9).

The loop filter is similar to other standard decoders however the VCO incorporates an additional low pass filter (4.7 nF and 33 kΩ) to reduce beat note distortion an additional 20 dB.

### Input Interface

There are two inputs to the LM1870, one for the PLL (pin 2) and the normal audio input (pin 19). The input impedance of the audio input is about 40 kΩ. The input coupling capacitor works with this input resistance and sets the low frequency response and separation.

The PLL input (pin 2) locks onto the 19 kHz pilot and rejects the rest of the composite signal. For this reason it is only necessary to use a coupling capacitor large enough to insure there is no phase shift at 19 kHz. The input resistance of the PLL is 14 kΩ so a capacitor between 0.01  $\mu$ F and 0.1  $\mu$ F would be fine. However, the source driving this input must not be affected by this load. This is true only when the source is low impedance (less than 100Ω).

Typical FM IF circuits have detector output impedance of 5 kΩ or more. This will cause very poor low frequency response and separation unless the loading is made constant over frequency. For this reason the typical input coupling capacitor is 2  $\mu$ F.

### IF Correction

The separation in most radios is limited by the response of the IF. The input lead network below can often be used to improve radio separation.

IF Correction Lead Network

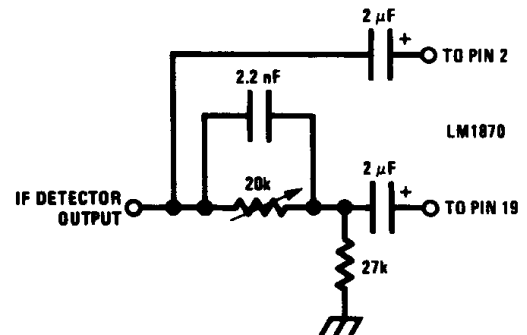

TL/H/7910-8

### Power Supply

The LM1870 is designed to work on supplies from 7V to 15V. For automotive applications a regulator is recommended to protect against transients; the LM2930-8V is the ideal choice.

This datasheet has been downloaded from:

[www.DatasheetCatalog.com](http://www.DatasheetCatalog.com)

Datasheets for electronic components.

# National Semiconductor was acquired by Texas Instruments.

[http://www.ti.com/corp/docs/investor\\_relations/pr\\_09\\_23\\_2011\\_national\\_semiconductor.html](http://www.ti.com/corp/docs/investor_relations/pr_09_23_2011_national_semiconductor.html)

This file is the datasheet for the following electronic components:

LM1870N - <http://www.ti.com/product/lm1870n?HQS=TI-null-null-dscatalog-df-pf-null-wwe>

LM1870M - <http://www.ti.com/product/lm1870m?HQS=TI-null-null-dscatalog-df-pf-null-wwe>